



BCE Product Offering 2024

The mission of the Bureau of Correctional Enterprises is to enhance public safety by providing jobs and training for inmates where they develop marketable skills and experience in financially viable businesses while producing quality products and services for our customers.

Mission Statement



Vision Statement

The Bureau of Correctional Enterprises makes a demonstrable contribution to public safety through our valued staff. We provide training and work experience for inmates that leads to long term success while in prison and in the community upon re-entry. Together we provide high-quality products and services to our customers.

Table of Contents



2	About Us & Table of Contents A few words about BCE
4	Seating Collection Ergonomic Task/Lounge/Guest/Stools and HD
10	Innovative Tables Intuitive Height adj./Fixed top/and Flip-Top
16	Files/Storage Essentials Durable Cabinets and Bookcases
20	Modern Desking Contemporary Workspaces
24	Versatile Panel Systems Flexible room defining privacy screens
26	Adaptive Accessories Ease of use Monitor arms/S2S/Lighting
30	Full Line of Services Custom Furniture/Space Planning-CADD/Quick ship programs/ Warranties/Professional Installation/Knowledgeable sales staff



ALT3 Task Chair

Seating Collection

HD TASK CHAIRS



Pilot HD Task



CXO HD Task



24/7 HD Task

TASK CHAIRS

• Click on any image for more information



NLC Task



Vex Task



Onda High Back



S1 Task



Genie Copper Mesh



EC Collection



Ithaca Ultra Mid Back



Navigator Air *



CXO Task

GUEST CHAIRS/STOOLS

* have nesting options available



NLC Task Stool



Rigger4 Cafe Stool



Ithaca Ultra Stool



Navigator Air Stool *



Sitka Task Stool



Ithaca Ultra Mesh Back



Strive High Density



Affton Guest Chair



Voli Guest Chair

LOUNGE/SOFT SEATING COLLECTION

• Click on any image for more information



Jessa Lounge Chair



Jessa Loveseat



Jessa Sofa

Jessa



Trullo One Seater



Trullo Two Seater



Trullo Three Seater

Trullo



Suave One Seater



Suave Loveseat



Suave Sofa

Suave



OFGO LOUNGE/SOFT SEATING

• Click on any image for more information



Vibe Collection



Vibe Oblongs One/Two Notches



Jazz Collection



Jazz Chair w/ tablet arm



Waterfall Collection



Waterfall Two Seater



Unify Collection



Unify Collection



Tribute Collection



Tribute Two Seater



Triumph LX
Electric Height Adj.

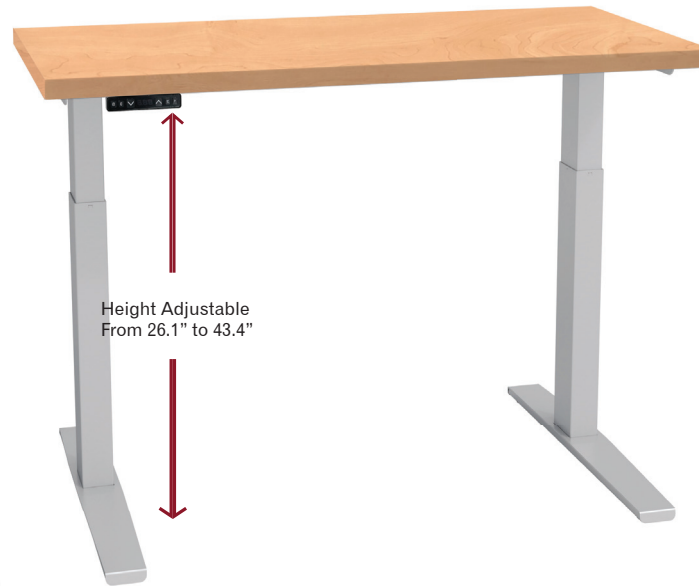

- Digital programmable switch with 3 memory settings.
- Keypad can slide under worksurface to store out of the way.

L Series
Electric Height Adj.



- Dual motor electric base.
- Simple Up/Down switch.
- 3-Stage base.

HEIGHT ADJUSTABLE TABLES

• Click on any image for more information

W Series
Electric Height Adj.



- Also Available with:
- Crank adj. base
 - Counter balance base

Titan



- 275lb max load capacity
- Whisper motors at 49db

Titan Pro



- 350lb max load capacity
- Multiple handset switch options

FIXED TOP TABLES

• Click on any image for more information

T Series



- Adj. glides standard.
- 29" Unit height.
- Various table top choices.

P Series



- Adj. glides standard.
- 29" Unit height.
- Caster option available.

E Series



- Multiple leg finish options.
- 29" Unit height.
- Various table top choices.

L Series



- Multiple edge styles.
- 29" Unit height.
- 3 base finish choices.

FLIP-TOP TABLES

V-Flip



- Aluminum construction.
- Easy pull flip mechanism.
- Cable management tray and vertical cord manager.
- Integrated retractable hook.
- Leveling casters.
- Base Supports 24" deep worksurfaces.

T Series



- Nesting capable.
- Multiple edge colors.
- Available quick-release or folding modesty panel.

R-SERIES COLLECTION

- Click on an image for more information



Pirouette Rectangular Nesting Table



Pirouette Round Nesting Table

R-Series

R-Table is a comprehensive table line that offers a variety of worksurface shapes, base styles and heights to help create cohesive and adaptive spaces. This unique design accommodates two-sided usage, giving ample leg room to those seated on either side of the table. R-Table supports a variety of environments from classrooms to cafes.

VINI FILES/STORAGE COLLECTION

- To learn more click on the product name

Wardrobe/Cabinet/Bookcase



Wardrobe/Cabinet/File



Lateral File (3 High)



Supporting Pedestal File



Overhead Shelf



Mobile Pedestal File

Vini

Create a productive, efficient workplace with Vini Storage. Blending a contemporary aesthetic and focus of efficiency with an old-fashioned concept of value. Vini offers solutions for a range of modern office environments. Storage elements maximize space, making the most of small footprints without compromising functionality.

SERIES XXI FILES/STORAGE COLLECTION

• To learn more click on the product name

Series XXI

Series XXI marries heavy-gauge steel construction with a simple clean design to create file and storage solutions of unsurpassed quality and function for the modern office. With pedestal files, vertical files, lateral files, kiosks, bookcases, and design-your-own systems all included in the family, you are sure to find a perfect fit for your office needs.

Locker Kiosk Cupboard



Lateral File (3 High)



Locker Kiosk with Doors



Mobile Pedestal File



Bookcase (1 Shelf)



Freestanding Pedestal File

STYLELINKS COLLECTION

• Click on an image for more information



Stylelinks

All benching designs begin with a charge to create furniture that encourages both team and individual productivity as efficiently as possible. Stylelinks answers the call by uniquely offering a floating top, simple leg design, and multi-tasking features throughout.

Other features available:

- Privacy screens for open office environments
- Storage solutions including pedestal files, credenzas and lockers
- Cafe height benching
- Dry erase mobile screens

Stylelinks Rectilinear Worksurface featured with Modesty Panel and Mobile dry erase screen

MARATHON SERIES

• Click on image for more information



STATEMENT OF LINE

Desks & Bridges

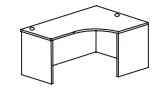

Square Shoe

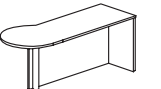

P-Shape

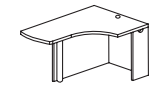

Arcade

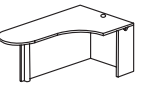

Piano Shape

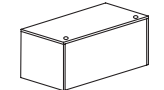

Rectangular



Curved Executive

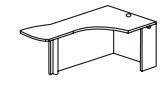

F-Shape

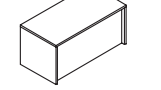

Straight Executive

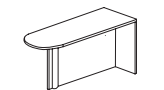

D-Shape

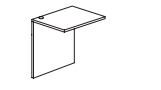

Bridge

Credenzas & Hutches

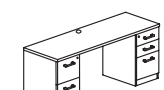

Rectangular Credenza

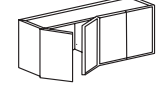

Wall Hanging Hutch

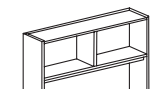

Hutch without Doors

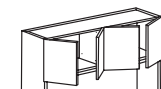

Hutch with Doors

Marathon Typical 1 (Carbon Oak Laminate) featured with NLC Task Chair

LEGION PANEL SYSTEMS

- To learn more click on the image



Legion Panel System

Traditional workstation layouts continue to have a place in the 21st century because they are effective. Some tasks simply require the concentration and attention that is facilitated by a space to call one's own. Legion recognizes that need and leverages its unique profile and mix of materials to create traditional space plans that feel fresh and modern.

Legion Preconfigured Panels featured with W Series Height Adj. Table



S2S Workstation

Adaptive Accessories

MONITOR ARMS

ESI



Sena Single Monitor Arm

ESI



Sena Dual Monitor Arms

VIVO



Single Monitor Arm with 2 Extentions

VIVO



Dual Monitor Arm with 2 Extentions

TASK LIGHTING

• Click on any image for more information



Tuck Light
Available in 12" - 44"



Lily Series Task Light

S2S WORKSTATION

- Click on an image for more information

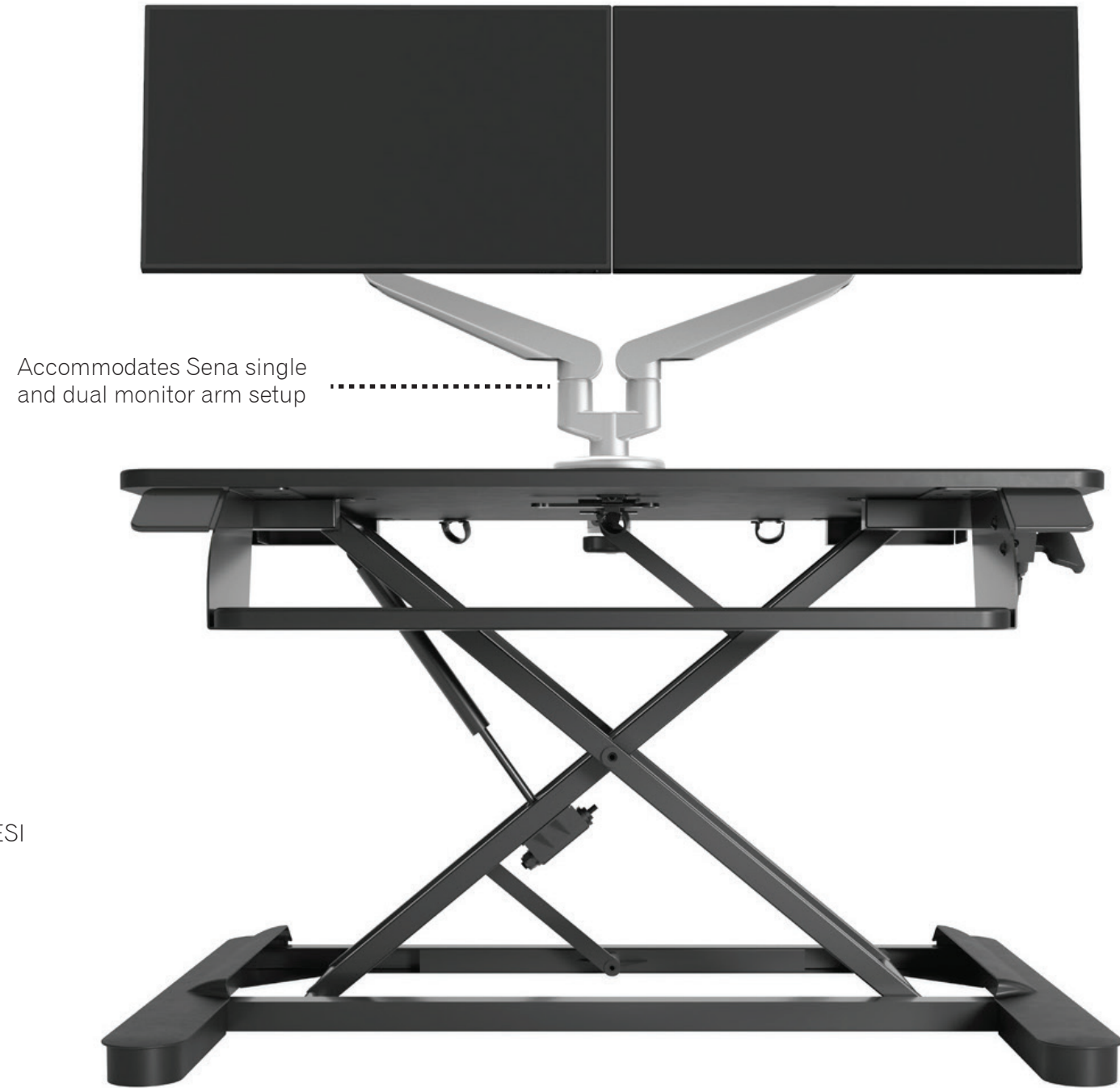

Accommodates Sena single and dual monitor arm setup

ESI

S2S Workstation with Monitor Arms

POWER MODULES



Nacre Pop-Up Module



Undermount R8 Module

OUR BCE LOCATIONS

BCE has 16 teams, with workers from 11 correctional facilities throughout the state of Wisconsin. Our agriculture operations are comprised of farm and dairy operations at three sites in Wisconsin, Badger State Logistics and our Industries Distribution Center both function out of Waupun, WI. Our Transition Program operates out of BCE's central office in Madison.

Agriculture

- Waupun & Fox Lake Farms** - Dairy Cows, Crops
- Waupun Dairy** - Milk, Ice cream, and Sherbet
- Oregon Farm** - Dairy Cows, Crops

Logistics

- Badger State Logistics** - Commodities Warehouse
- Industries Distribution Center** - Transportation, Storage, Delivery & Installation Computer Recycling

Transition

- Transition Program** - BCE Central Office

Industries

- LAUNDRY & LINEN RENTALS** - Oshkosh Correctional Institution
- TEXTILES & EMBROIDERY** - Green Bay Correctional Institution
- METAL FABRICATION & STAMPING** - Waupun Correctional Institution
- PRODUCT DEVELOPMENT CENTER** - Oshkosh Correctional Institution
- UPHOLSTERY** - Oshkosh Correctional Institution
- PRINTING** - Columbia Correctional Institution
- WOOD FABRICATION** - Fox Lake Correctional Institution
- SIGN HYDRO-STRIPPING** - New Lisbon Correctional Institution
- ROAD & TRAIL SIGNS** - Jackson Correctional Institution
- DURABLE MEDICAL EQUIP. REFURBISHING** - Red Granite Correctional Institution
- CUSTOM SIGNS** - Stanley Correctional Institution

Full Line of Services

Quick Ship Program for Chairs



BCE's Quick ship program includes a 7 day lead time with up to 5 chairs per order, and a regular 5% shipping charge. A \$50 handling fee per chair has been added to the NET cost for shipping and packaging. For more information, please contact BCE or your Sales Representative at 608.240.5200 or 1.800.862.1086.



Custom Designed Furniture

- Click on service title for more information

We can customize furniture to fit any office configuration and any size desk, table, or drawer.

Does your office have challenging requirements or a unique floor space? Do you need your office furniture to come in a variety of configurations? Or do you simply want to be involved in the process of designing your furniture to have the custom look that you desire? Then look no further than BCE's Custom Furniture.



CADD Drawings / Space Planning

Free services provided by BCE sales and Design staff include: initial sales call with customer, a site measurement, programming, initial drawings plus up to two revisions, final drawing and bill of materials, and final review of order by BCE staff before placing into production.

CUSTOMER APPROVAL

By signing off on this drawing the customer agrees this drawing depicts their desired design and they approve the design for purchase. This is not a P.O., but an acknowledgement of approval of the design.

CUSTOMER NAME (Print): _____

CUSTOMER SIGNATURE: _____

DATE: _____

NOTE: PULLS SHOWN ARE FOR SIMULATION PURPOSES ONLY, AND WILL BE REPLACED WITH CUSTOMER-CHOSEN HARDWARE AFTER APPROVAL IS FINALIZED.

DATE PRINTED: 12/21/2022

UW OSHKOSH CREDENZA



UW Oshkosh Credenza Drawing

Warranties

The Bureau of Correctional Enterprises (BCE) furniture product warranties are subject to the BCE suppliers then current terms. This means that BCE furniture customers will enjoy the exact warranty coverage that the BCE vendor(s) is offering on the date that the BCE customer places their order.

EXCEPTIONS to these terms are:

- BCE OEM Products - 10 year warranty
- Foam, casters, slides, glides, task lighting - 1 year warranty
- Cylinder & Mechanism (Parts only - 10 years, Labor - 2 years)
- Fabrics, leather, mesh, upholstery, vinyl - 3 year warranty
- Arm rest fabric and padding on all seating - 1 year warranty
- Computer accessories - 1 year warranty

EXCLUSIONS – Warranty does not cover:

- Failure resulting from normal wear and tear which is to be expected over the course of ownership.
- Any misuse, abuse, or modification of the original product voids the warranty.
- Products that are exposed to extreme environmental conditions or that have been subject to improper storage.
- Alterations to product not expressly authorized by BCE, nor to products considered to be of a consumable nature such as bulbs, light ballasts, and surge suppression products.
- Customer Own Material (COM) including labor costs.
- Natural variations in wood grain; changes in surface finishes, including colorfastness, due to aging or exposure to light; matching of color, grain or texture, except to within commercially acceptable standards.
- BCE product warranty terms begin from the date the Authorized Users receive the product.
- BCE agrees its products will be free from defect in materials and workmanship, given normal use and care. All product warranties are based on usage from a single 8-hour shift, per day, unless otherwise noted.
- BCE products are not intended or warranted for outdoor use unless specifically stated for outdoor use.
- Products (including parts and components) that fail under normal use as a result of a defect in design, materials, workmanship, or installation shall be repaired or replaced free of charge (including labor, delivery and installation) throughout the warranty period.
- Products that require warranty repair or replacement must be repaired or replaced within a time frame that is agreed upon, in writing, with the Authorized User.

Textiles Warranty

All product is warranted against defective workmanship and material identified from date of shipment. BCE is not responsible for damage to product due to misuse, neglect, or circumstances beyond our control. The following is made in lieu of warranties expressed or implied: BCE's only obligation shall be to repair (at manufacture's option) such defective material. BCE shall not be liable for any injury, loss or damage, direct or consequential, arising out of the use or inability to use the product. Before using; user shall determine the suitability of the product for intended use and the user assumes all risk and liability whatsoever in connection therewith.

Professional Installation Services

Delivery and Installation Services

Delivery and Installation services can be provided anywhere in the state at the cost of 5% and 8% of the order respectively (Delivery 5%, Installation 8%). These rates may be subject to change per Department of Administration (DOA) contract changes.

The following information must be provided with the purchase order when requesting installation of furniture orders:

- Two contact persons and phone numbers.
- Specific floor and room numbers.
- Availability of freight elevator.
- Size of elevator.
- Are stairs the only access to floor location?
- Width of stairs.
- Width of narrow hallways or doors.
- Is the area under construction?

Providing this information prior to delivery is key to a well-planned, successful installation. Occasional delivery delays may be experienced due to scheduling considerations on installed deliveries. It is the responsibility of the customer to have the job site prepared to accept BCE product. It is not the responsibility of BCE staff or designee to remove existing furniture.

Full Service Sales Staff

BCE Outside / Inside Sales Staff

The Bureau of Correctional Enterprises (BCE) has a knowledgeable sales staff available to serve you. To assist our Outside Sale Consultants, we have a team of Inside salespeople who can handle all customer service and special inquiries. Their knowledge and expertise will assist you from the beginning of the process through the design, CADD drawing, quote, and ordering processes.

[Click here for a territory map and comprehensive contact information for each territory's BCE sales member\(s\)](#)

North Territory

Kevin Erickson
BCE Furniture Sales Consultant
Work Cell: 715-210-0868
Kevin.Erickson@wisconsin.gov

Sean Klimek
Inside Sales Representative
Office: 608-240-5250
Sean.Klimek@wisconsin.gov

Southwest Territory

Leigh Jahn
BCE Furniture Sales Consultant
Office: 608-225-2446
Leigh.Jahn@wisconsin.gov

Lukas Adams
Inside Sales Representative
Office: 608-240-5228
Lukas.Adams@wisconsin.gov

Southeast Territory

Michelle Pressentin
BCE Furniture Sales Consultant
Office: 608-444-2679
Michelle.Pressentin@wisconsin.gov

Lindsay Bents
Inside Sales Representative
Office: 608-240-5211
Lindsay.Bents@wisconsin.gov



OFGO WATERFALL
ONE & TWO SEAT

FURNITURE SALES REPRESENTATIVES

NORTH TERRITORY

Kevin Erickson
BCE Furniture Sales Consultant
Work Cell: 715.210.0868
E-mail: Kevin.Erickson@wisconsin.gov

Sean Klimek
Inside Sales Representative
Office: 608.240.5250
E-mail: Sean.Klimek@wisconsin.gov

SOUTHWEST TERRITORY

Leigh Jahn
BCE Furniture Sales Consultant
Work Cell: 608.225.2446
E-mail: Leigh.Jahn@wisconsin.gov

Lukas Adams
Inside Sales Representative
Work Cell: 608.240.5228
E-mail: Lukas.Adams@wisconsin.gov

SOUTHEAST TERRITORY

Michelle Presentin
BCE Furniture Sales Consultant
Work Cell: 608.444.2679
E-mail: Michelle.Presentin@wisconsin.gov

Lindsay Bents
Inside Sales Representative
Work Cell: 608.240.5211
E-mail: Lindsay.Bents@wisconsin.gov

